

HARRIER



— FEEL THE PRESENCE —



AN UNMISTAKABLE PRESENCE

The Harrier marries sheer confidence with elegance in a harmonious bond, captivating onlookers in every way.



Bi-LED HEADLAMP

Look sharp and leave a lasting impression with the striking Daytime Running Lights coupled with the smart Adaptive High-beam System.

AUTO RETRACTABLE WING MIRROR WITH LED SIGNAL LAMP & WELCOME LIGHT

Be greeted with style every time you enter and exit.



REAR LED COMBINATION LAMPS

A distinctive look with rear combination lamps, all integrated into the bumper.



18" ALLOY RIMS

Black coating and silver spokes create a sporty, elegant look.

DUAL OVAL MUFFLER

Every drive becomes a joy ride with reduced exhaust resistance and noise.



KICK-SENSOR POWER BACK DOOR

Kick it up a notch and load up your Harrier, hands-free.

A LUXURIOUS FEEL

One step inside its luscious cabin will tell you all you need to know about the Harrier — that beauty is not just skin deep.



FEEL THE DETAILS

No aspect of the drive is left unconsidered. Wherever your journey leads, the Harrier makes every mile enjoyable.



SMART ENTRY & START SYSTEM

Strategically located and accessible from passenger's seat during emergencies.

DIGITAL REAR VIEW MIRROR

Easily switches to digital mode for greater clarity and field of vision, even at night.





DUAL ZONE AUTOMATIC CLIMATE CONTROL

Both driver and passenger can enjoy the perfect temperature. No compromises needed. Comes with nanoe™ X Technology & S-FLOW Control for your comfort and fuel efficiency.

LEATHER SEATS

Have a seat – the Harrier's dark, dignified interior adds prestige and class to every ride.



HIGH GRADE OPTITRON METER

Gorgeously paired with the elegant Head-up Display and Colour Multi-information Display.

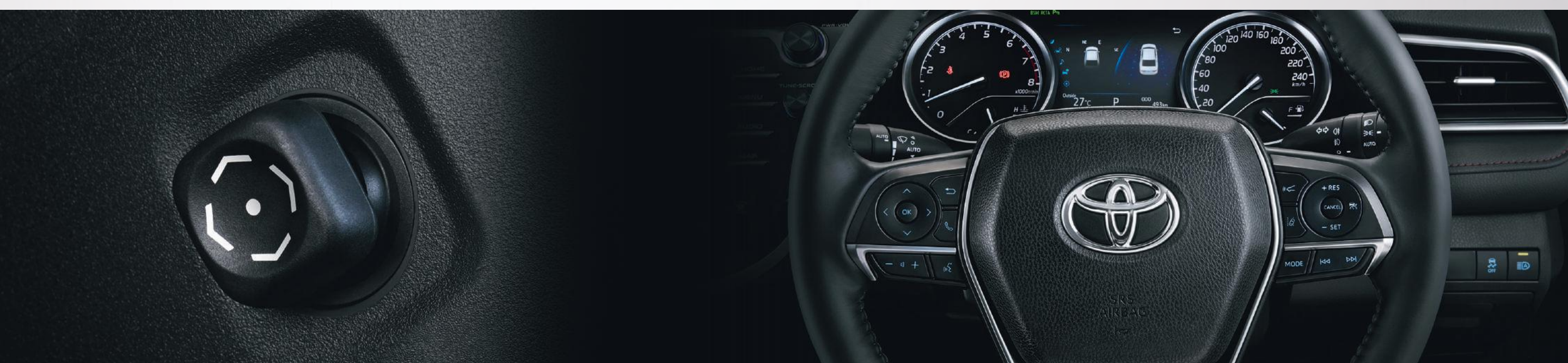

STEER WITH CONFIDENCE

Be in control of the Harrier without sacrificing comfort, simply by adjusting the distance of the steering wheel to your preference which you can save as a preset.



FIXED PANORAMIC MOON ROOF

At the push of a button, experience the world the way you want to, completely opened or pleasantly dimmed.



FRONT & REAR USB-C PORTS

Multiple USB-C ports for convenient charging of several devices simultaneously.

WIRELESS CHARGER

Keep your phone battery juiced up with the wireless charger that works for Qi* standard-compliant devices.

*International standard for wireless charging developed by Wireless Power Consortium



LUGGAGE SPACE

Leave nothing behind when you go on the road—they can all fit in the Harrier's extra large storage.

PRESENCE OF POWER & CONTROL

The Harrier responds faster and better to your every command. At last, the drive is one with the driver.



POWERFULLY SILENT

Sound-insulation materials are strategically positioned around the Harrier, resulting in a calm and quiet cabin.



2.0 LITRE

173 PS
Maximum power

203 Nm
Maximum torque

15.3* km/l
Fuel efficiency

40 %
Thermal efficiency

*Number based on internal tests

2.0L DYNAMIC FORCE ENGINE

Conquer the city with improved acceleration along with greater fuel efficiency.



DRIVE MODE SWITCH

Intelligently placed to easily switch between ECO, Sport and Normal mode.

DIRECT SHIFT CONTINUOUSLY VARIABLE TRANSMISSION (CVT)

Sequential Shiftmatic and additional start-off gear results in seamless shifting and smoother drives.

TNGA

Toyota
New
Global
Architecture



TNGA Platform with Double Wishbone Rear Suspension

The optimal weight balance, double wishbone rear suspension and stronger vehicle body provide the stability, agility and security you need for better driving performance.

SAFETY

New TNGA bonding methods for more secured body. And with advanced materials to spread out impact force, you can drive easy knowing the Toyota design has been tested for maximum safety.

STABILITY

We lowered the front of the car for better viewing. The new TNGA design also features a lower body and better weight distribution. More speed. More control.

AGILITY

TNGA is also designed for enjoyment as the suspension has been tuned for improved and steady performance. Lighter parts also allow for more power with less fuel use. Get the best drive out of your TNGA designed vehicle.



TOYOTA SAFETY SENSE

Cruise safely on the road with the Harrier's cutting edge safety features—because the most precious thing in every Toyota is the people inside.

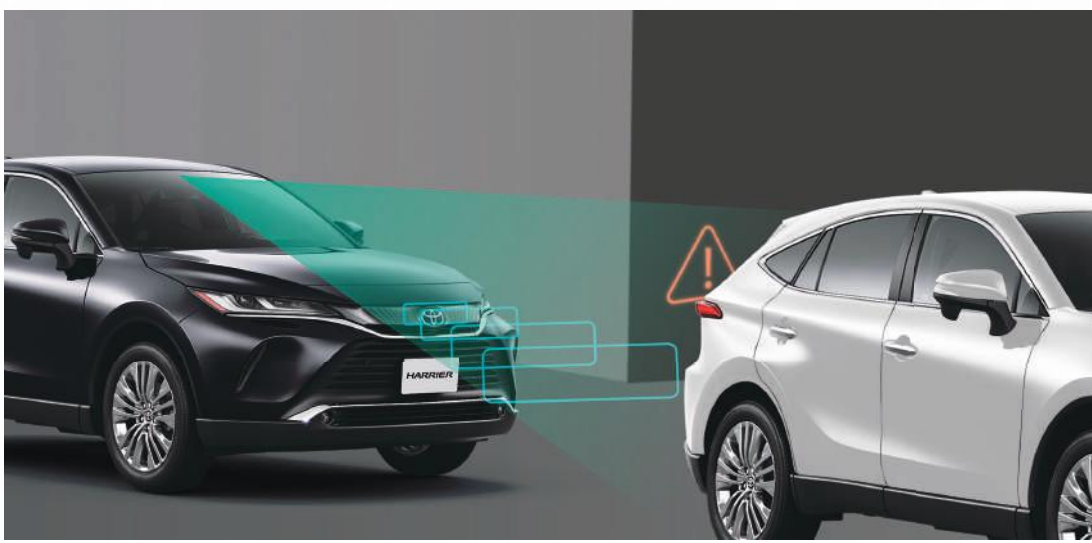

PRE-COLLISION SYSTEM (PCS)*

Avoids or mitigates frontal collisions by automatically applying brakes while alerting the driver during a risk of collision. Detects oncoming vehicles and bicyclists during the day, and pedestrians during both day and night.



LANE DEPARTURE ALERT (LDA) WITH STEERING ASSIST*

Alerts driver when vehicle is out of lane and detects any Road Edge Detection such as curb and grass. Steering assist also provides additional steering pressure to correct any lane deviation.



LANE TRACING ASSIST (LTA)*

Keeps the vehicle centered either by detecting the lane or preceding vehicle.



DYNAMIC RADAR CRUISE CONTROL (DRCC) FOR ALL SPEEDS*

Maintains a safe distance from the preceding vehicle, braking automatically when the vehicle ahead stops. Able to control the speed during a curve turn.

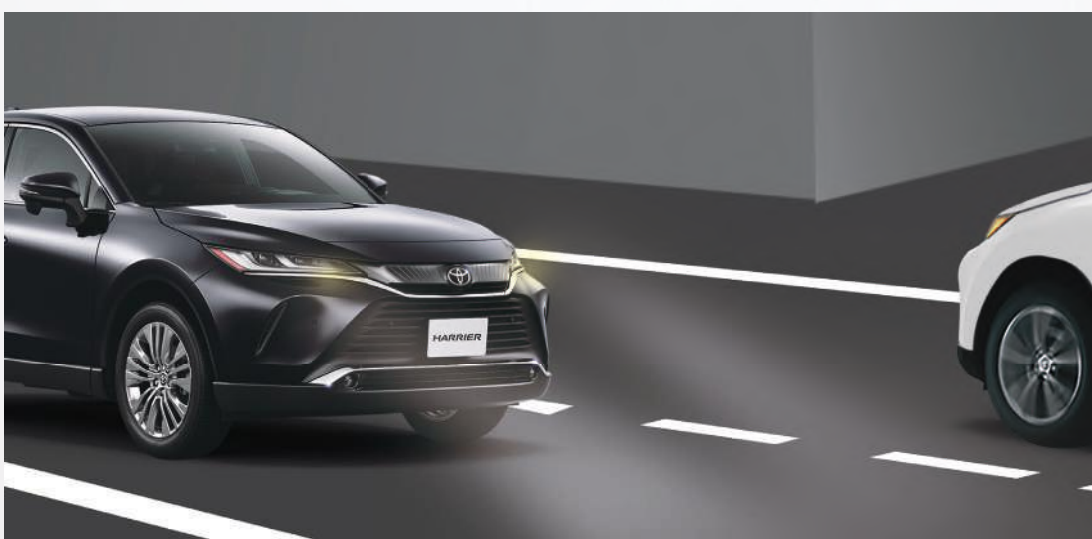

ADAPTIVE HIGH-BEAM SYSTEM (AHS)*

Uses multiple independently controlled LEDs arranged in a single row, giving a wider range of illumination than earlier systems without dazzling the drivers of preceding and oncoming vehicles.

360-T ADVANCED

It's all about Trust & Technology by Toyota

SAFE-T Trust for smoother journeys ahead



TYRE PRESSURE MONITORING SYSTEM (TPMS)

Displays real-time tyre pressure information via multi-information display (MID). Alerts driver when tyre pressure is below ideal level.



BLIND SPOT MONITOR (BSM) WITH REAR CROSS TRAFFIC AUTO BRAKE (RCTAB)

The Blind Spot Monitor alerts you of vehicles in your blind spot area, so you can switch lanes safely and confidently.



ELECTRIC PARKING BRAKE (EPB) + AUTO BRAKE HOLD

Keeps the vehicle stationary on flat roads with a simple button. Automatically releases during acceleration.



7 AIRBAGS

Experience safer journeys in the Harrier, equipped with 7 SRS airbags that protect you and your passengers.



FRONT & REAR DIGITAL VIDEO RECORDER (DVR)

Record your journeys from the front and back for your protection, in case of emergencies or accidents.



HILL-START ASSIST CONTROL (HAC)

The Hill-Start Assist Control keeps the Harrier from rolling backwards on a steep slope.

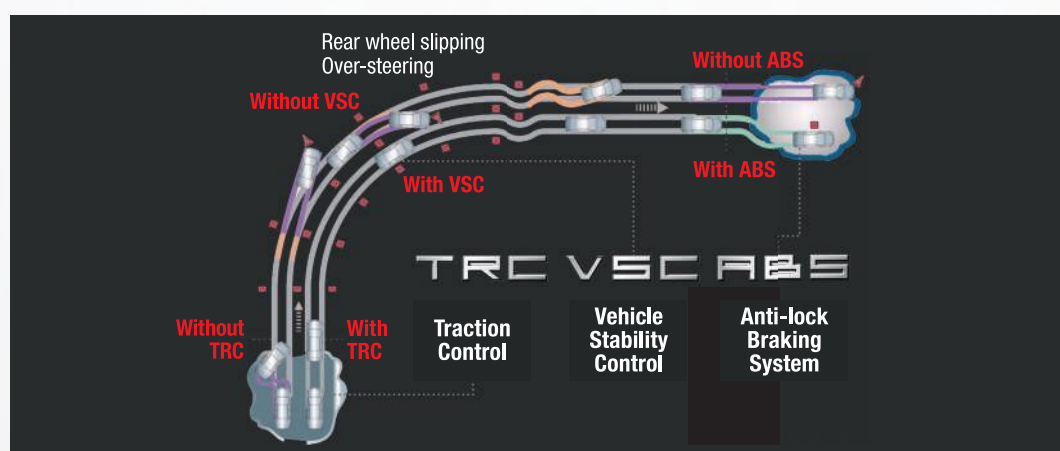

VEHICLE STABILITY CONTROL (VSC) & TRACTION CONTROL (TRC)

Always be in control of the Harrier even on slippery surfaces, thanks to Traction Control that improves traction, as well as Vehicle Stability Control that applies braking to individual wheels.

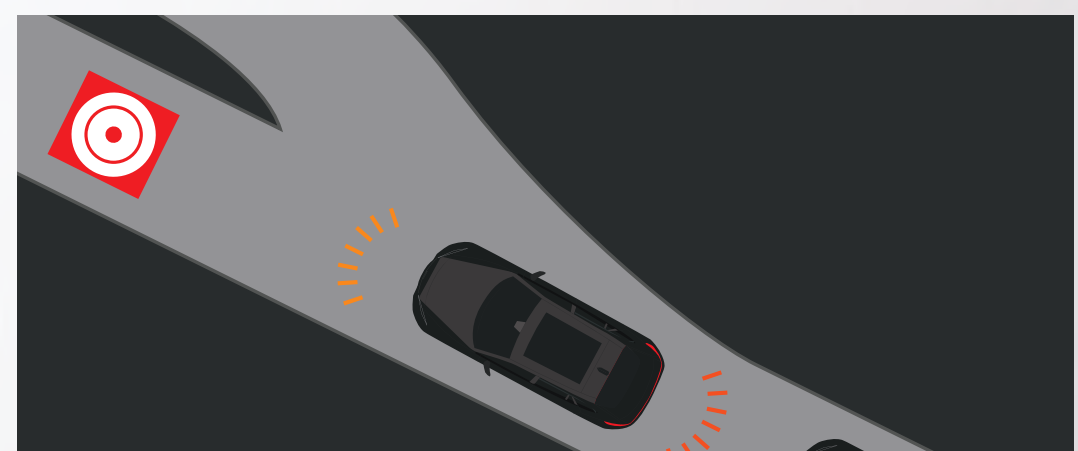

EMERGENCY STOP SIGNAL (ESS) WITH BRAKE ASSIST (BA)

Sudden braking will cause the emergency signals of the Harrier to flash, to warn vehicles behind it, while Brake Assist ensures that maximum braking force is applied when an emergency is detected.

360-T ADVANCED

It's all about Trust & Technology by Toyota

SAFE-T Trust for smoother journeys ahead

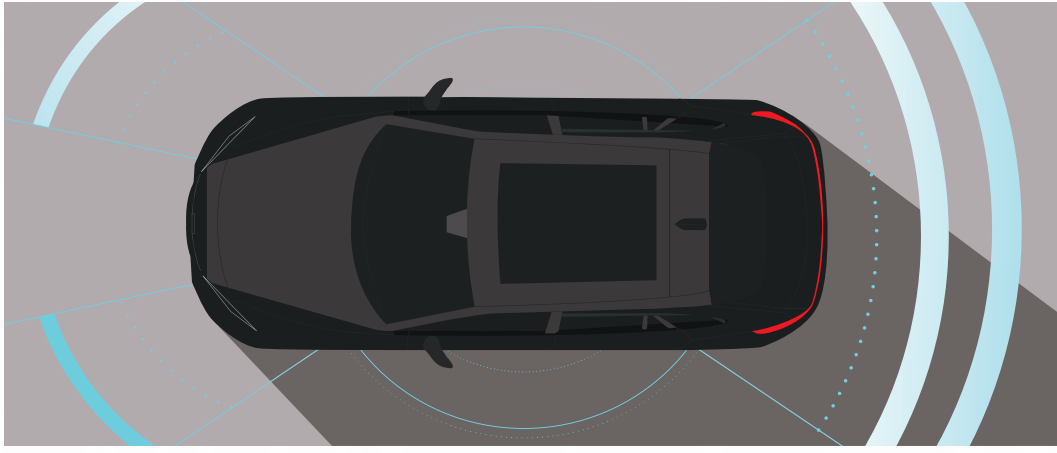

PARKING SENSOR (FRONT & REAR) & INTELLIGENT CLEARANCE SONAR

When objects are in close proximity, sensors will alert the driver, while the car reduces engine power and brakes automatically.



TOYOTA PREMIUM SECURITY & SOLAR FILM

Security meets comfort - prevent glass from break-ins easily, reflect harmful rays and keep the cabin cool.

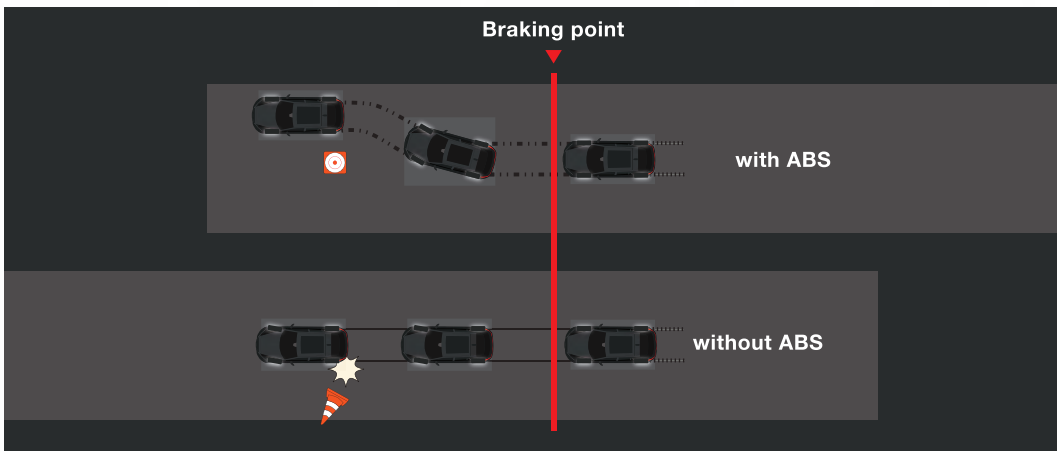

ANTI-LOCK BRAKING SYSTEM (ABS) WITH ELECTRONIC BRAKE-FORCE DISTRIBUTION (EBD)

Prevents tyres from locking during braking, for more stable stops especially on slippery road surfaces.



PANORAMIC VIEW MONITOR (PVM)

Get a detailed 360° view of your vehicle for manoeuvring in tight spaces.

CONNECTIVI-T Technology at your command



VEHICLE TELEMATICS SYSTEM (VTS)

An integrated system that monitors and shares your vehicle's real-time location through a mobile app.



APPLE CARPLAY & ANDROID AUTO-READY CONNECTIVITY (AACP)*

8-inch touchscreen display with reverse camera. USB, AUX, and Bluetooth compatible.

360-T ADVANCED

It's all about Trust & Technology by Toyota

GUARAN-T Total peace of mind



5 years warranty with unlimited mileage from date of the first registration. Terms and Conditions apply.

COLOUR



PLATINUM WHITE PEARL
089



STEEL BLONDE METALLIC
4X1



DARK BLUE METALLIC
8X8



SLATE GREY METALLIC
1K9



PRECIOUS BLACK
219



SPECIAL EDITION
RED METALLIC
3T3

SPECIFICATIONS

VARIANT	2.0 LUXURY SE		2.0 LUXURY	
ENGINE				
Model	M20A-FKS			
Type	4-cylinder, In-line, 16-Valve DOHC; VVT-iE(Intake) & VVT-i(Exhaust)			
Displacement	cc	1,987		
Max. Output	PS / rpm	173 / 6,600		
Max. Torque	Nm /rpm	203 / 4,400-4,900		
TRANSMISSION				
Type	Direct Shift Continuously Variable Transmission			
CHASSIS				
Suspension	Front / Rear	MacPherson Strut with Stabiliser / Trailing Wishbone with Stabiliser		
Brakes	Front / Rear	Ventilated Disc / Solid Disc		
Tyres & Rims	225/60R18, Alloy			
Spare Tyre	Temporary Tyre			
Steering	Electric Power Steering			
MEASUREMENTS				
Overall	Length / Width / Height	(mm)	4,740 / 1,855 / 1,660	
Wheelbase	(mm)		2,690	
Tread	Front / Rear	(mm)	1,605 / 1,625	
Kerb Weight	(kg)		1,610	
Min. Turning Radius	(m)		5.7	
Fuel Capacity	(Litre)		55	
EXTERIOR FEATURES				
Headlamps	Type	Automatic Bi-LED Projector with LED Turn Signals		
Daytime Running Lights	With (LED)			
Fog Lamps	Front / Rear	With (LED) / With (LED)		
Rear Combination Lamps	With (LED)			
Welcome Lights	With			
Wing Mirrors	Auto Retractable with Turn Signal Lamp & Puddle Lamp			
Panoramic Moon Roof	With (Fixed)			
Power Back Door	With (Kick Sensor)			
Wipers	Front / Rear	Automatic with Rain Sensor / Intermittent		
Exhaust System	Dual Muffler			
INTERIOR FEATURES				
Audio System	Type	Display Audio with 8" Capacitive Touch Screen, Wireless Apple CarPlay & Wired Android Auto-ready Connectivity* & Bluetooth®		
	Speakers	6		
	3.5mm AUX Jack	Without		
Door Trim	Leather with Black and Brown Trim		Leather with Black Trim	
Air Conditioning	Dual Zone, Automatic Climate Control with Rear Vents			
Nanoë™ X	With			
Meter Panel	Type	Optitron		
	Multi-Information Display (MID)	7" Colour TFT		
Seats	Material / Colour	Combination Leather / Black with Brown Stitching	Combination Leather / Black with Black Stitching	
	Front Seat	Driver	12-way Power Adjustable with 2-position Memory	
		Passenger	4-way Power Adjustable	
	Ventilated Seats		With	
	Rear Seat	60:40 Split Fold & Recline		
	Rear Armrest	With Cupholders		
Smart Entry & Start System	With			
Heads up Display	With			
Wireless Charger	With			
USB Charging Ports	5-ports Front: USB C (Data) + Dual USB C (Charging) Rear: Dual USB C (Charging)			
Inside Rear View Mirror	Digital Mirror			
Steering Wheel	Power Adjustment	With (4-Way)		
	Auto Tilt Away	With		
	Material	Leather		
	Steering Switches	With		
Interior Lights	LED (Dome, Map, Glove Box, Footwell, Door Handle, Door Courtesy, Vanity & Scuff Plate)			
Tonneau Cover	With			
Digital Video Recorder (DVR)	With (Front & Rear)			
Navigation	With			
Luggage Tray	With			
Front Side Glass	Laminated			

SPECIFICATIONS

VARIANT	2.0 LUXURY SE	2.0 LUXURY
SAFETY		
Toyota Safety Sense	Pre-Collision System (PCS)	With
	Lane Departure Alert (LDA)	With
	Lane Tracing Assist (LTA)	With
	Dynamic Radar Cruise Control (DRCC)	With (All Speeds)
	Adaptive High-beam System (AHS)	With
Vehicle Stability Control (VSC)	With Traction Control (TRC) & Hill-start Assist Control (HAC)	
Anti-lock Braking System (ABS)	With Electronic Brake-Force Distribution (EBD) & Brake Assist (BA)	
Panoramic View Monitor (PVM)	With	
Emergency Stop Signal (ESS)	With	
Electric Parking Brake	With Automatic Brake Hold	
Intelligent Clearance Sonar (ICS)	With (Front and Rear)	
Blind Spot Monitor (BSM)	With Rear Cross Traffic Auto Brake (RCTAB)	
Tyre Pressure Monitoring System (TPMS)	With (With Individual Tyre Readout)	
SRS Airbags	7 (Driver, Front Passenger, Side, Curtain & Driver Knee)	
Seatbelts	Front	3-point ELR x 2 with Pretensioner & Force Limiter
	Rear	3-point ELR x 2 with Pretensioner & Force Limiter + 3-point ELR x 1
	Reminder	With (Front & Rear)
ISOFIX	With (Outboard Rear Seats)	
SECURITY		
Security System	2 Remote Control Keys, Immobiliser	
Vehicle Telematics System (VTS)	With	
Toyota Premium Security & Solar Film	With	

*Functions availability may vary depending on smartphones. For details, please contact your nearest Toyota showroom.

DIMENSIONS

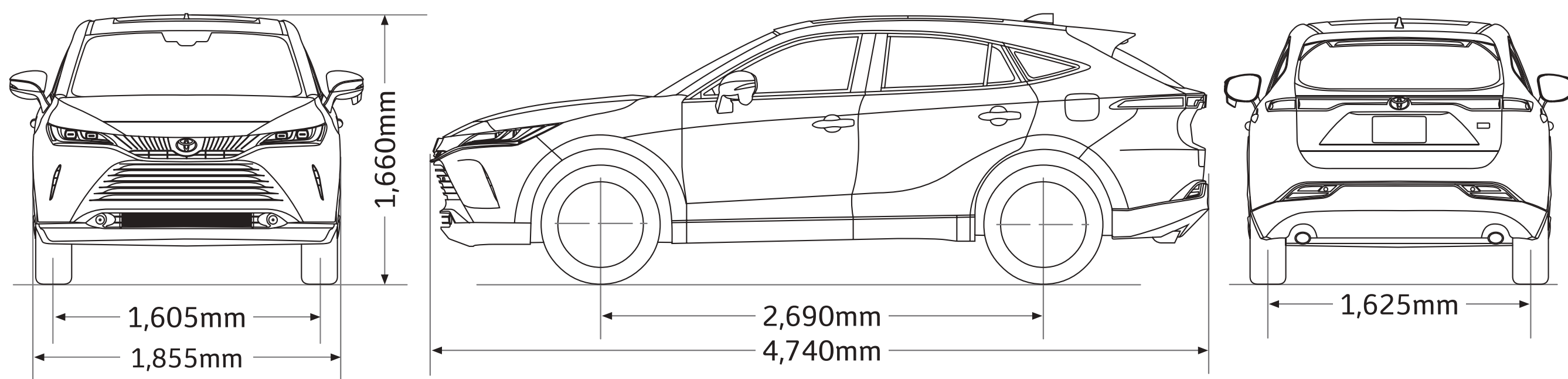

5 years warranty from the date of first registration with unlimited mileage. Terms and Conditions apply.



For Your Auto-Financing Needs

- UMW Toyota Motor reserves the right to alter any details of specifications and equipment without notice.
- Details of specifications and equipment are also subject to change to suit local conditions and requirements.
- Vehicle and specifications in this catalogue may vary from models available locally.
- Vehicle body and accessory colours might differ from the printed photos in this catalogue.
- All images used are for illustrative purposes.